

VOLTA - MODEL: DDT41

4" Recessed Adjustable Downlight

WAC

PROJECT:

TYPE:

Product Image



Line Drawing

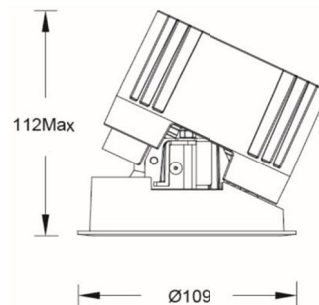

Product Description

VOLTA series LED round narrow-edge recessed angle downlights have a streamlined appearance and adopt precise lens and black mirror reflector designs to ensure that the light is emitted while still achieving the ultimate anti-glare effect. The light source cavity adopts a sealed design, which can minimize the impact of humid environment on its performance, and the reflector or optical accessories can be freely disassembled and replaced, which greatly improves on-site convenience and is mainly suitable for hotels and commercial indoor places.

Product Features

- Body Material: Aluminum alloy die-casting
- Optical System: Lens+ SUBOROSA optical system
- Finish: Static electricity powder coating
- Adjustable Angle: 0-25° tilt
- Accessories: As attached
- Certification: CCC/CE
- IP Rating: IP20(Light source cavity IP44)
- Insulation Level: Class II
- Operating Temperature: -20°C~40°C

Product Specifications

- Cut-out: Ø100
- Ceiling Thickness: 1mm~20mm
- Shielding Angle: 30°
- LED Type: COB (8° use HP LED)
- Source Lm:
 - 2700K: 8W 685lm; 13W 1380lm; 18W 1860lm
 - 3000K: 8W 720lm; 13W 1465lm; 18W 1975lm
 - 3500K: 8W 750lm; 13W 1540lm; 18W 2070lm
 - 4000K: 8W 765lm; 13W 1600lm; 18W 2155lm
 - 5000K: 8W 775lm; 13W 1645lm; 18W 2220lm
- LED Lifetime: >50000h-L70 /B10-Ta25°C(LM-80/TM-21)
- CCT/CRI: 2700K/ 3000K/3500K/4000K/5000K, Ra90
- SDCM: 3 SDCM (4000K 5SDCM)
- Input: 220V~240V AC / 50Hz
- Dimming: On-off / 0-10V /DALI (must do compatibility test in advance with the project site system)
- Net Weight: 0.6Kg without packing

Order Model

Model	Size	Trim	LED	Driver	Beam	CCT	Reflector	Finish
DDT Downlight T series	4	1 Round Trim	LD08 LED 8W	E ON-OFF	N 8°	27 2700K	B Black S Specular	WT White
			LM13 COB 13W	D 0-10V	1 15°	30 3000K		BK Black
			LM18 COB 18W	N NO DRIVER	2 24°	35 3500K		
				A DALI	3 36°	40 4000K		
					5 50°	50 5000K		

Example: DDT41-LM18E-S230SWT

WAC Lighting
www.waclighting.com (US)
www.waclighting.com.cn (China)

Headquarters
44 Harbor Park Drive • Port Washington, NY
Phone (516) 515.5000 • Fax (516) 515.5050

WAC Lighting(Shanghai)
14,Lane 299, Bi Sheng Road, Shanghai 201204,China
Phone (86.21) 3393.3558 • Fax (86.21) 3362.1598



VOLTA - MODEL: DDT41

4" Recessed Adjustable Downlight



PROJECT:

TYPE:

<p>LENS-DLT41-BEL Striped glass lens</p> 	<p>LENS-DLT41-HCL Honeycomb</p> 
---	--

Note: A maximum of one optical accessory can be installed. The accessories are not shipped from the factory and need to be ordered separately.

LIGHT DISTRIBUTION@3000K LUMINAIRE DATA

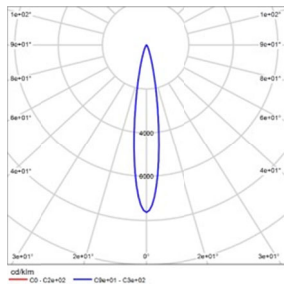

MODEL: DDT41-LM13E-130SWT
BEAM ANGLE: 15°
POWER: 15W
LUMENS: 884lm
CBCP: 6749cd
EFFICACY: 59lm/W

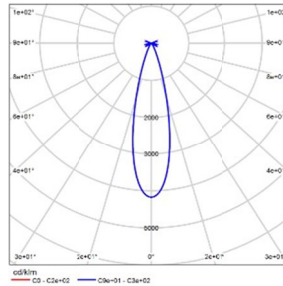

MODEL: DDT41-LM13E-230SWT
BEAM ANGLE: 24°
POWER: 15W
LUMENS: 1128lm
CBCP: 4708cd
EFFICACY: 75lm/W

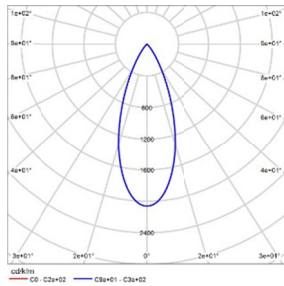

MODEL: DDT41-LM13E-330SWT
BEAM ANGLE: 36°
POWER: 15W
LUMENS: 1204lm
CBCP: 2482cd
EFFICACY: 80lm/W

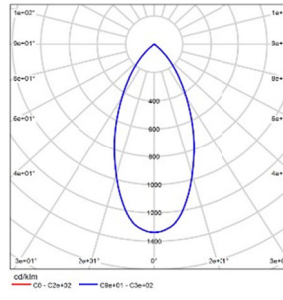

MODEL: DDT41-LM13E-530SWT
BEAM ANGLE: 50°
POWER: 15W
LUMENS: 995lm
CBCP: 1330cd
EFFICACY: 66lm/W

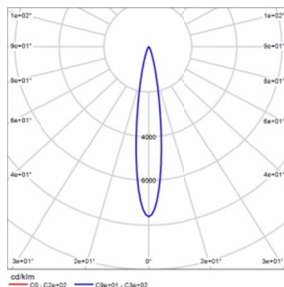

MODEL: DDT41-LM18E-130SWT
BEAM ANGLE: 15°
POWER: 22W
LUMENS: 884lm
CBCP: 6749cd
EFFICACY: 59lm/W

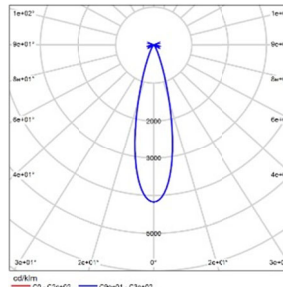

MODEL: DDT41-LM18E-230SWT
BEAM ANGLE: 24°
POWER: 21W
LUMENS: 1128lm
CBCP: 4708cd
EFFICACY: 75lm/W

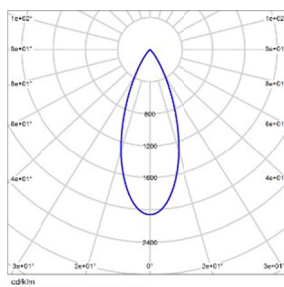

MODEL: DDT41-LM18E-330SWT
BEAM ANGLE: 36°
POWER: 21W
LUMENS: 1712lm
CBCP: 3529cd
EFFICACY: 82lm/W

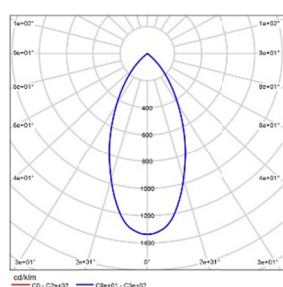

MODEL: DDT41-LM18E-530SWT
BEAM ANGLE: 50°
POWER: 21W
LUMENS: 1414lm
CBCP: 1891cd
EFFICACY: 67lm/W

VOLTA - MODEL: DDT41
4" Recessed Adjustable Downlight

WAC

PROJECT:

TYPE:

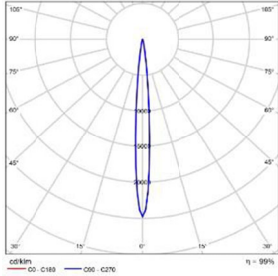

MODEL:	DDT41-LD08E-S30SWT
BEAM ANGLE:	8°
POWER:	11W
LUMENS:	375lm
CBCP:	9280cd
EFFICACY:	34lm/W

VOLTA - MODEL: DDT51

5" Recessed Adjustable Downlight

WAC

PROJECT:

TYPE:

Product Image



Line Drawing

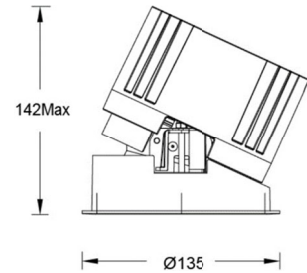

Product Description

VOLTA series LED round narrow-edge recessed angle downlights have a streamlined appearance and adopt precise lens and black mirror reflector designs to ensure that the light is emitted while still achieving the ultimate anti-glare effect. The light source cavity adopts a sealed design, which can minimize the impact of humid environment on its performance, and the reflector or optical accessories can be freely disassembled and replaced, which greatly improves on-site convenience and is mainly suitable for hotels and commercial indoor places.

Product Features

- Body Material: Aluminum alloy die-casting
- Optical System: Lens+ SUBOROSA optical system
- Finish: Static electricity powder coating
- Adjustable Angle: 0-25° tilt
- Accessories: As attached
- Certification: CCC/CE
- IP Rating: IP20(Light source cavity IP44)
- Insulation Level: Class II
- Operating Temperature: -20°C~40°C

Product Specifications

- Cut-out: Ø125
- Ceiling Thickness: 1mm~20mm
- Shielding Angle: 30°
- LED Type: COB (8° use HP LED)
- Source Lm:
 - 2700K: 24W 2055lm; 18W 1860lm; 25W 2460lm; 32W 3065lm
 - 3000K: 24W 2160lm; 18W 1975lm; 25W 2610lm; 32W 3255lm
 - 3500K: 24W 2250lm; 18W 2070lm; 25W 2710lm; 32W 3380lm
 - 4000K: 24W 2295lm; 18W 2155lm; 25W 2790lm; 32W 3480lm
 - 5000K: 24W 2325lm; 18W 2220lm; 25W 2870lm; 32W 3580lm
- LED Lifetime: >50000h-L70 /B10-Ta25°C(LM-80/TM-21)
- CCT/CRI: 2700K/ 3000K/3500K/4000K/5000K, Ra90
- SDCM: 3 SDCM (4000K 5SDCM)
- Input: 220V~240V AC / 50Hz
- Dimming: On-off / 0-10V /DALI (must do compatibility test in advance with the project site system)
- Net Weight: 1.0Kg without packing

Order Model

Model	Size	Trim	LED	Driver	Beam	CCT	Reflector	Finish
DDT Downlight Directional T series	5"	1 Round Trim	LD24 LED 24W	E On-Off D 0-10V Dimming	S 8°	27 2700K	B Black	WT White
			LM18 COB 18W		1 15°	30 3000K	S Specular	BK Black
			LM25 COB 25W		2 24°	35 3500K		
			LM32 COB 32W	3 36°	40 4000K			
			LM32 COB 32W	5 50°	50 5000K			
				N No Driver A DALI				

Example: DDT51-LM25E-230SWT

WAC Lighting
www.waclighting.com (US)
www.waclighting.com.cn (China)

Headquarters
44 Harbor Park Drive • Port Washington, NY
Phone (516) 515.5000 • Fax (516) 515.5050

WAC Lighting(Shanghai)
14,Lane 299, Bi Sheng Road, Shanghai 201204,China
Phone (86.21) 3393.3558 • Fax (86.21) 3362.1598

WAC Lighting reserves the right to periodically design and update products.2024-01-20

VOLTA - MODEL: DDT51

5" Recessed Adjustable Downlight



PROJECT:

TYPE:

LENS-DLT51-BEL Striped glass lens	LENS-DLT51-HCL Honeycomb
---	------------------------------------

Note: A maximum of one optical accessory can be installed. The accessories are not shipped from the factory and need to be ordered separately.

LIGHT DISTRIBUTION@3000K LUMINAIRE DATA

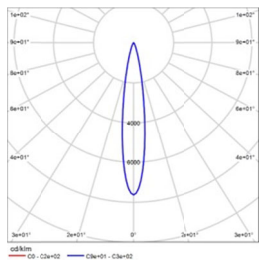

MODEL: DDT51-LM18E-130SWT
BEAM ANGLE: 15°
POWER: 21W
LUMENS: 1609lm
CBCP: 14044cd
EFFICACY: 77lm/W

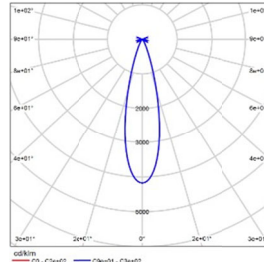

MODEL: DDT51-LM18E-230SWT
BEAM ANGLE: 24°
POWER: 21W
LUMENS: 1640lm
CBCP: 6742cd
EFFICACY: 78lm/W

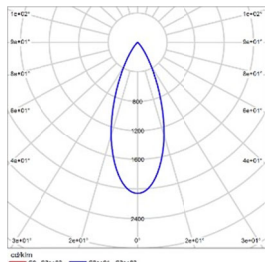

MODEL: DDT51-LM18E-330SWT
BEAM ANGLE: 36°
POWER: 21W
LUMENS: 1783lm
CBCP: 3738cd
EFFICACY: 85lm/W

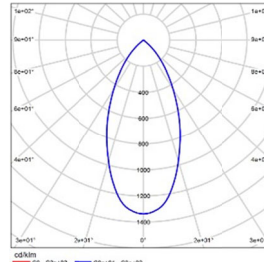

MODEL: DDT51-LM18E-530SWT
BEAM ANGLE: 50°
POWER: 21W
LUMENS: 1538lm
CBCP: 2311cd
EFFICACY: 73lm/W

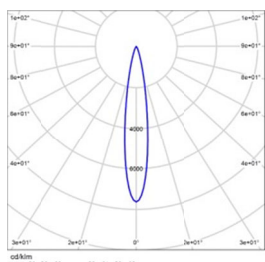

MODEL: DDT51-LM25E-130SWT
BEAM ANGLE: 15°
POWER: 28W
LUMENS: 2111lm
CBCP: 18431cd
EFFICACY: 75lm/W

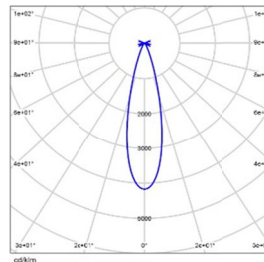

MODEL: DDT51-LM25E-230SWT
BEAM ANGLE: 24°
POWER: 28W
LUMENS: 2152lm
CBCP: 8848cd
EFFICACY: 77lm/W

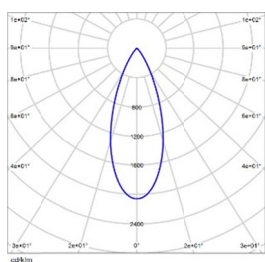

MODEL: DDT51-LM25E-330SWT
BEAM ANGLE: 36°
POWER: 28W
LUMENS: 2340lm
CBCP: 4905cd
EFFICACY: 84lm/W

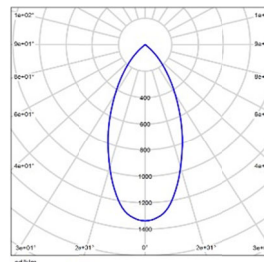

MODEL: DDT51-LM25E-530SWT
BEAM ANGLE: 50°
POWER: 28W
LUMENS: 2018lm
CBCP: 3033cd
EFFICACY: 72lm/W

VOLTA - MODEL: DDT51
5" Recessed Adjustable Downlight



PROJECT:

TYPE:

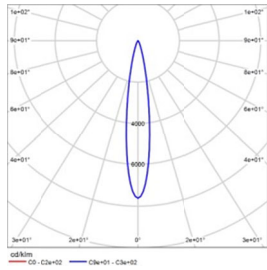

MODEL: DDT51-LM32E-130SWT
BEAM ANGLE: 15°
POWER: 35W
LUMENS: 2630lm
CBCP: 22965cd
EFFICACY: 75lm/W

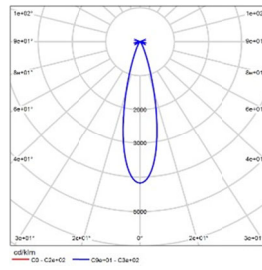

MODEL: DDT51-LM32E-230SWT
BEAM ANGLE: 24°
POWER: 35W
LUMENS: 2682lm
CBCP: 11024cd
EFFICACY: 77lm/W

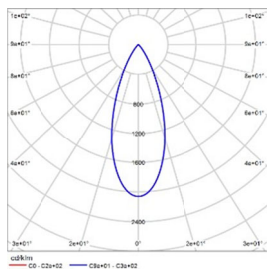

MODEL: DDT51-LM32E-330SWT
BEAM ANGLE: 36°
POWER: 35W
LUMENS: 2916lm
CBCP: 6112cd
EFFICACY: 83lm/W

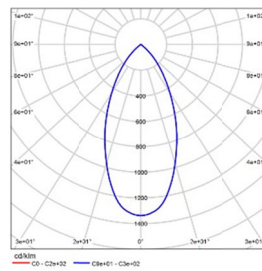

MODEL: DDT51-LM32E-530SWT
BEAM ANGLE: 50°
POWER: 35W
LUMENS: 2514lm
CBCP: 3779cd
EFFICACY: 72lm/W

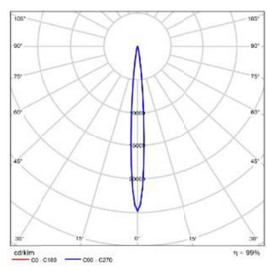

MODEL: DDT51-LD24E-S30SWT
BEAM ANGLE: 8°
POWER: 25W
LUMENS: 1125lm
CBCP: 27840cd
EFFICACY: 40lm/W

VOLTA - MODEL: DDT61
6" Recessed Adjustable Downlight



PROJECT:

TYPE:

Product Image



Line Drawing

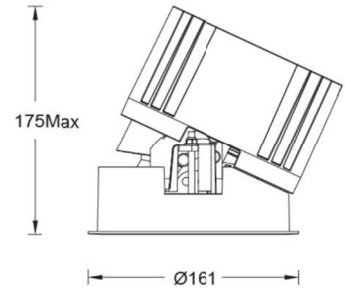

Product Description

VOLTA series LED round narrow-edge recessed angle downlights have a streamlined appearance and adopt precise lens and black mirror reflector designs to ensure that the light is emitted while still achieving the ultimate anti-glare effect. The light source cavity adopts a sealed design, which can minimize the impact of humid environment on its performance, and the reflector or optical accessories can be freely disassembled and replaced, which greatly improves on-site convenience and is mainly suitable for hotels and commercial indoor places.

Product Features

- Body Material: Aluminum alloy die-casting
- Optical System: Lens+ SUBOROSA optical system
- Finish: Static electricity powder coating
- Adjustable Angle: 0-25° tilt
- Accessories: As attached
- Certification: CCC/CE
- IP Rating: IP20(Light source cavity IP44)
- Insulation Level: Class II
- Operating Temperature: -20°C~40°C

Product Specifications

- Cut-out: Ø150
- Ceiling Thickness: 1mm~20mm
- Shielding Angle: 30°
- LED Type: COB (8° use HP LED)
- Source Lm:
 - 2700K: 32W 2740lm; 32W 3610lm; 43W 4250lm
 - 3000K: 32W 2880lm; 32W 3830lm; 43W 4505lm
 - 3500K: 32W 3000lm; 32W 4020lm; 43W 4730lm
 - 4000K: 32W 3060lm; 32W 4180lm; 43W 4920lm
 - 5000K: 32W 3100lm; 32W 4310lm; 43W 5065lm
- LED Lifetime: >50000h-L70 /B10-Ta25°C(LM-80/TM-21)
- CCT/CRI: 2700K/ 3000K/3500K/4000K/5000K, Ra90
- SDCM: 3 SDCM (4000K 5SDCM)
- Input: 220V~240V AC / 50Hz
- Dimming: On-off / 0-10V /DALI (must do compatibility test in advance with the project site system)
- Net Weight: 1.7Kg without packing

Order Model

Model	Size	Trim	LED	Driver	Beam	CCT	Reflector	Finish
DDT Downlight Directional T series	6"	1 Round Trim	LD32 LED 32W	E On-Off D 0-10V Dimming	S 8°	27 2700K	B Black	WT White BK Black
			LM32 COB 32W		1 15°	30 3000K	S Specular	
			LM43 COB 43W	N No Driver A DALI	2 24°	35 3500K		
			LM43 COB 43W		3 36°	40 4000K		
					5 50°	50 5000K		

Example: DDT61-LM43E-230SWT

WAC Lighting
 www.wacighting.com (US)
 www.wacighting.com.cn (China)

Headquarters
 44 Harbor Park Drive • Port Washington, NY
 Phone (516) 515.5000 • Fax (516) 515.5050

WAC Lighting(Shanghai)
 14,Lane 299, Bi Sheng Road, Shanghai 201204,China
 Phone (86.21) 3393.3558 • Fax (86.21) 3362.1598



VOLTA - MODEL: DDT61

6" Recessed Adjustable Downlight



PROJECT:

TYPE:

LENS-DLT61-BEL Striped glass lens 	LENS-DLT61-HCL Honeycomb 
---	--

Note: A maximum of one optical accessory can be installed. The accessories are not shipped from the factory and need to be ordered separately.

LIGHT DISTRIBUTION@3000K LUMINAIRE DATA

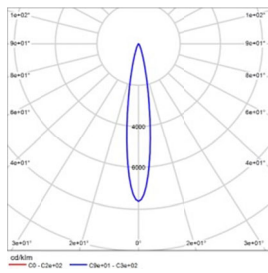

MODEL:	DDT61-LM32E-130SWT
BEAM ANGLE:	15°
POWER:	35W
LUMENS:	2393lm
CBCP:	23635cd
EFFICACY:	68lm/W

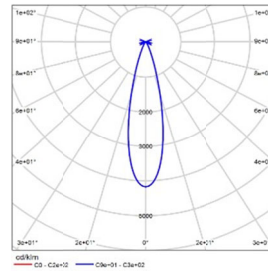

MODEL:	DDT61-LM32E-230SWT
BEAM ANGLE:	24°
POWER:	35W
LUMENS:	3015lm
CBCP:	13170cd
EFFICACY:	86lm/W

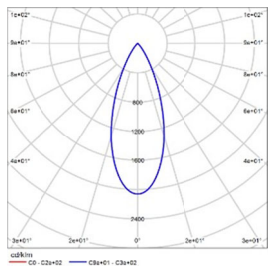

MODEL:	DDT61-LM32E-330SWT
BEAM ANGLE:	36°
POWER:	35W
LUMENS:	3001lm
CBCP:	6651cd
EFFICACY:	86lm/W

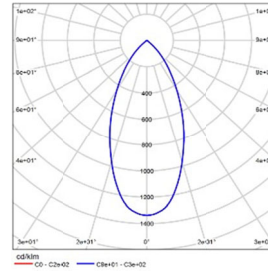

MODEL:	DDT61-LM32E-530SWT
BEAM ANGLE:	50°
POWER:	35W
LUMENS:	2830lm
CBCP:	3762cd
EFFICACY:	81lm/W

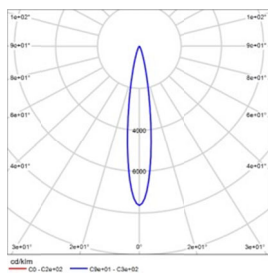

MODEL:	DDT61-LM43E-130SWT
BEAM ANGLE:	15°
POWER:	47W
LUMENS:	3108lm
CBCP:	30695cd
EFFICACY:	66lm/W

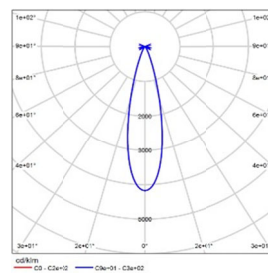

MODEL:	DDT61-LM43E-230SWT
BEAM ANGLE:	24°
POWER:	47W
LUMENS:	3916lm
CBCP:	17104cd
EFFICACY:	83lm/W

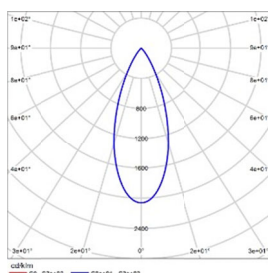

MODEL:	DDT61-LM43E-330SWT
BEAM ANGLE:	36°
POWER:	47W
LUMENS:	3897lm
CBCP:	8638cd
EFFICACY:	78lm/W

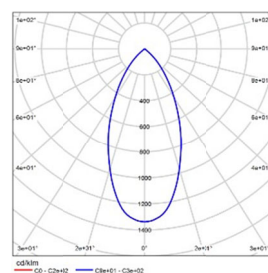

MODEL:	DDT61-LM43E-530SWT
BEAM ANGLE:	50°
POWER:	47W
LUMENS:	3675lm
CBCP:	4885cd
EFFICACY:	83lm/W

VOLTA - MODEL: DDT61
6" Recessed Adjustable Downlight

WAC

PROJECT:

TYPE:

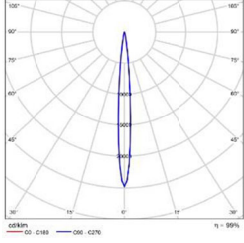

MODEL:	DDT61-LD32E-S30SWT
BEAM ANGLE:	8°
POWER:	35W
LUMENS:	1500lm
CBCP:	37120cd
EFFICACY:	43lm/W