

SWALLOW PRO- MODEL: ME21HLM

Surface Mounted Luminaires

WAC

PROJECT :

TYPE :

Product Image



Line Drawing

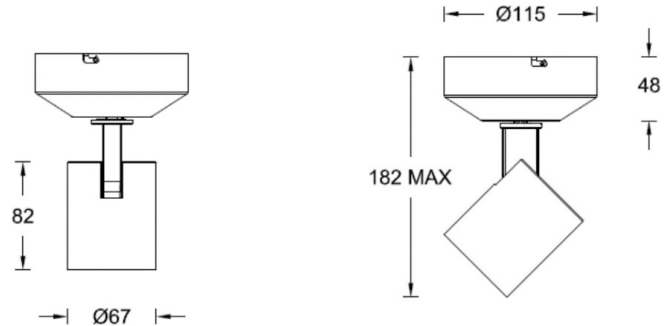

Product Descript

The Swallow Pro series LED ceiling spotlights are exquisitely designed for museums, art galleries, commercial spaces, hotels, retail, and high-end residential areas, providing professional key lighting and environmental lighting. This product is made of die cast aluminum with a built-in COB luminous module and no visible heat sink. There are two standard color temperature options available, with a wide range of beam angle types and high light flux, as well as excellent color rendering performance.

Product Features

- Body Material: Aluminum alloy die-casting
- Optical System: Lens
- Finish: Electrostatic powder coating, black (BK), white (WT)
- Adjustable Angle: 0-25° tilt
- Accessories: As attached
- Certification: CCC
- IP Rating: IP20
- Insulation Level: Class I
- Operating Temperature: -20°C~40°C

Product Specifications

- Light source type: COB
- Light source power: 6W and 12W optional
- Source Lm: 3000K: 660lm(6W)/1250lm(12W)
4000K: 720lm(6W)/1370lm(12W)
- LED Lifetime: >50000h-L70/B10-Ta25°C(LM-80/TM-21)
- CCT/CRI: 3000K/4000K, optional Ra90 or Ra97 (>Ra95)
- SDCM: 3 SDCM
- Input: 220V~240V AC / 50Hz
- Dimming: No dimming/0-10V (compatibility testing must be conducted with the project site system in advance)
- Net Weight: 1.1Kg without packing

Order Model

Model	LED	Dimming	Beam	CRI	CCT	Finish
ME21H Swallow Pro	LM06 COB 6W	E ON-OFF	1 12°	9 90	30 3000K	WT White
		D 0-10V	2 24°			
	LM12 COB 12W	Dimming	3 36°	A 97	40 4000K	BK Black
			5 55°			
ME21H	LM12	E	2	9	30	WT

Example : ME21HLM12-E-2930WT

SWALLOW PRO- MODEL: ME21HLM









Surface Mounted Luminaires

WAC

PROJECT :

TYPE :

Accessories

Class I Accessories	LENS-16-BEL-C Striped glass lenses 	LENS-16-BSL-SW Soft glass lenses 	LENS-16-FR Frosted glass lenses 	LENS-16-HCL Borderless honeycomb grille 
Class II Accessories	LENS-16-SNOOT Anti glare tube 	LENS-16-CRL Anti glare cross grille 	LENS-16-HCM Anti glare bee mesh grille 	
Class III Accessories	TL-21-BD-SW Four leaf shading board 			

Note: Up to three optical accessories can be added, and each type of accessory can only be added one at a time

LIGHT DISTRIBUTION@3000K LUMINAIRE DATA

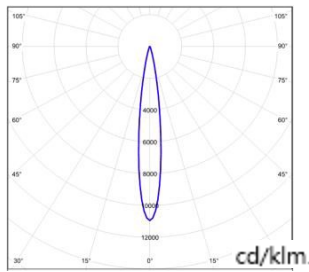

MODEL :	ME21HLM12-E-1930
BEAM ANGLE :	12°
POWER :	15W
LUMENS :	813LM
CBCP :	8896CD
EFFICACY :	54LM/W

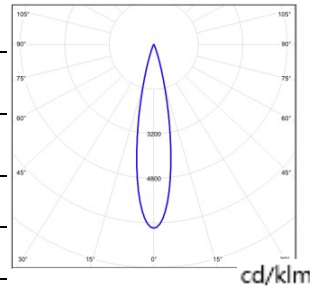

MODEL :	ME21HLM12-E-2930
BEAM ANGLE :	24°
POWER :	15W
LUMENS :	905LM
CBCP :	5963CD
EFFICACY :	60LM/W

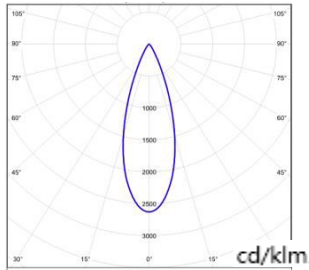

MODEL :	ME21HLM12-E-3930
BEAM ANGLE :	36°
POWER :	15W
LUMENS :	
CBCP :	968LM 2546CD
EFFICACY :	65LM/W

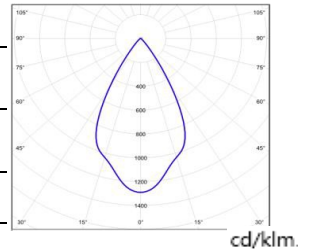

MODEL :	ME21HLM12-E-5930
BEAM ANGLE :	55°
POWER :	15W
LUMENS :	930LM
CBCP :	1200CD
EFFICACY :	62LM/W

SWALLOW PRO- MODEL: ME22HLM

Surface Mounted Luminaires

WAC

PROJECT :

TYPE :

Product Image



Line Drawing

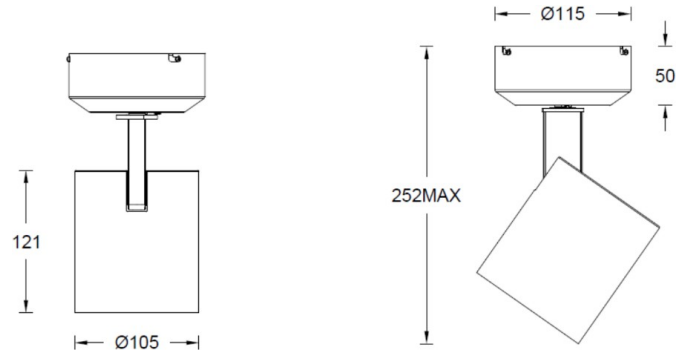

Product Descript

The Swallow Pro series LED ceiling spotlights are exquisitely designed for museums, art galleries, commercial spaces, hotels, retail, and high-end residential areas, providing professional key lighting and environmental lighting. This product is made of die cast aluminum with a built-in COB luminous module and no visible heat sink. There are two standard color temperature options available, with a wide range of beam angle types and high light flux, as well as excellent color rendering performance.

Product Features

- Body Material: Aluminum alloy die-casting
- Optical System: Lens
- Finish: Electrostatic powder coating, black (BK), white (WT)
- Adjustable Angle: Horizontal adjustment from 0 ° to 365 °; Vertical 0-90 ° adjustment
- Accessories: As attached
- Certification: CCC
- IP Rating: IP20
- Insulation Level: Class I
- Operating Temperature: -20°C~40°C

Product Specifications

- Light source type: COB
- Light source power: 18W, 28W, or 38W optional
- Source Lm: 3000K:1970lm(18W) /3010lm(28W)/3520lm(38W) 4000K:2150lm(18W) /3100lm(28W)/3850lm(38W)
- LED Lifetime: >50000h-L70/B10-Ta25°C(LM-80/TM-21)
- CCT/CRI: 3000K/4000K, optional Ra90 or Ra97 (>Ra95)
- SDCM: 3 SDCM
- Input: 220V~240V AC / 50Hz
- Dimming: No dimming/0-10V (compatibility testing must be conducted with the project site system in advance)
- Net Weight: 2.0Kg without packing

Order Model

Model	LED	Dimming	Beam	CRI	CCT	Finish
ME22H Swallow Pro	LM18 COB 18W	E ON-OFF	1 12°	9 90 A 97	30 3000K 40 4000K	WT White BK Black
	LM28 COB 28W	D 0-10V	2 24°			
	LM38 COB 38W	Dimming	3 36° 5 50°			
ME21H	LM12	E	2	9	30	WT

Example : ME22HLM28-E-2930WT

SWALLOW PRO- MODEL: ME22HLM









Surface Mounted Luminaires



PROJECT :

TYPE :

Accessories

Class I Accessories	LENS-25-BEL-SW Striped glass lenses 	LENS-25-BSL Soft glass lenses 	LENS-25-FR-SW Frosted glass lenses 	LENS-25-LCM- Borderless honeycomb grille 
Class II Accessories	LENS-25-SNOOT-SW Anti glare tube 	LENS-25P-CRL-BK Anti glare cross grille 	ENS-25-HCL Anti glare bee mesh grille 	
Class III Accessories	TL-21-BD-SW Four leaf shading board 			

Note: Up to three optical accessories can be added, and each type of accessory can only be added one at a time

LIGHT DISTRIBUTION@3000K LUMINAIRE DATA

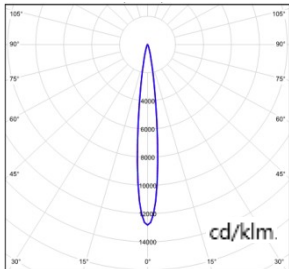

MODEL : ME22HLM18-E-1930
BEAM ANGLE : 12°
POWER : 21W
LUMENS : 1382lm
CBCP : 17696cd
EFFICACY : 66lm/W

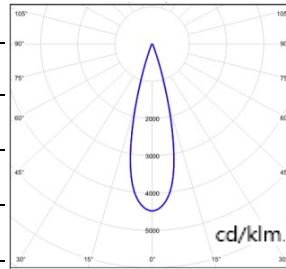

MODEL : ME22HLM18-E-2930
BEAM ANGLE : 24°
POWER : 21W
LUMENS : 1450lm
CBCP : 6491cd
EFFICACY : 69lm/W

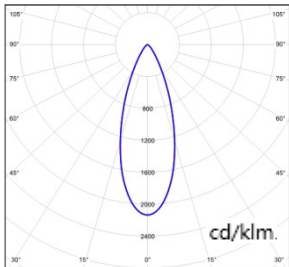

MODEL : ME22HLM18-E-3930
BEAM ANGLE : 36°
POWER : 21W
LUMENS : 1405lm
CBCP : 2999cd
EFFICACY : 67lm/W

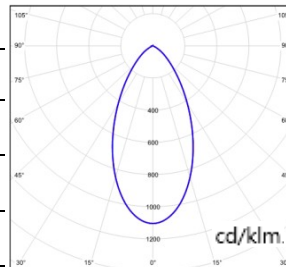

MODEL : ME22HLM18-E-5930
BEAM ANGLE : 50°
POWER : 21W
LUMENS : 1391lm
CBCP : 1536cd
EFFICACY : 66lm/W

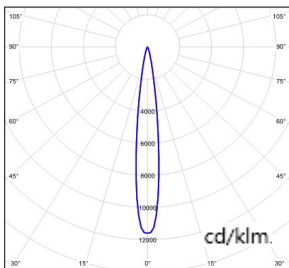

MODEL : ME22HLM28-E-1930
BEAM ANGLE : 12°
POWER : 35W
LUMENS : 2157lm
CBCP : 25010cd
EFFICACY : 65lm/W

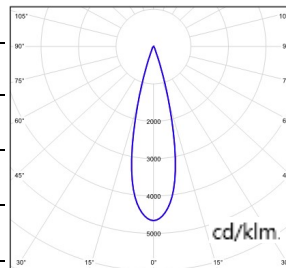

MODEL : ME22HLM28-E-2930
BEAM ANGLE : 24°
POWER : 35W
LUMENS : 2261lm
CBCP : 10525cd
EFFICACY : 65lm/W

SWALLOW PRO- MODEL: ME22HLM

Surface Mounted Luminaires

WAC

PROJECT :

TYPE :

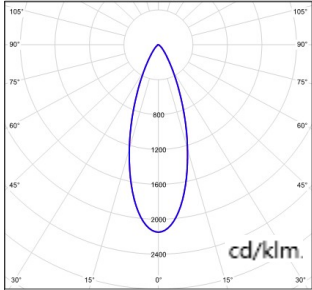

MODEL : ME22HLM28-E-3930

BEAM ANGLE : 36°

POWER : 35W

LUMENS : 2184LM

CBCP : 4691CD

EFFICACY : 62LM/W

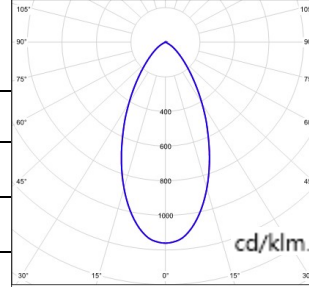

MODEL : ME22HLM28-E-5930

BEAM ANGLE : 50°

POWER : 35W

LUMENS : 2190LM

CBCP : 2541CD

EFFICACY : 63LM/W

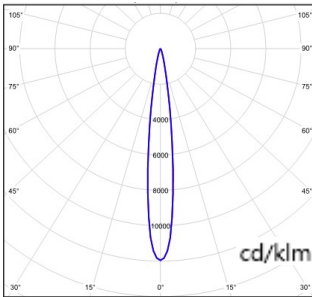

MODEL : ME22HLM38-E-1930

BEAM ANGLE : 12°

POWER : 45W

LUMENS : 2846LM

CBCP : 34012CD

EFFICACY : 63LM/W

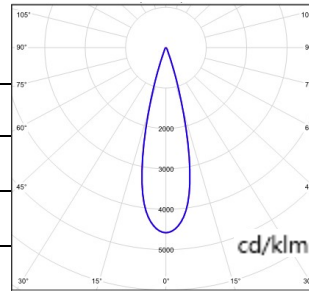

MODEL : ME22HLM38-E-2930

BEAM ANGLE : 24°

POWER : 45W

LUMENS : 2985LM

CBCP : 13670CD

EFFICACY : 66LM/W

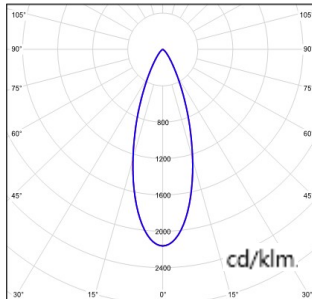

MODEL : ME22HLM38-E-3930

BEAM ANGLE : 36°

POWER : 45W

LUMENS : 2907LM

CBCP : 6281CD

EFFICACY : 65LM/W

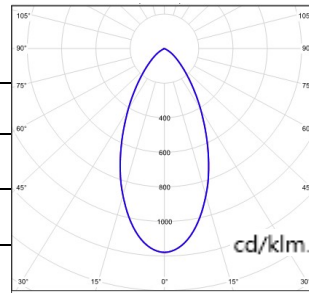

MODEL : ME22HLM38-E-5930

BEAM ANGLE : 50°

POWER : 45W

LUMENS : 2883LM

CBCP : 3397CD

EFFICACY : 64LM/W