

FUEGO PRO- MODEL: EIS1S

In-ground Luminaires

WAC

PROJECT:

TYPE:

Product Image



Line Drawing

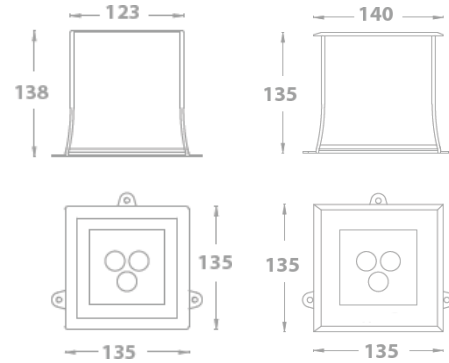

Product Description

The IP67 waterproof design and FUEGO PRO buried lamp are equipped with a patented anti condensation design, featuring symmetrical and asymmetrical wall sweeping and projection light distribution. The unique adjustable device allows for on-site adjustment of the light direction, with an adjustment range of 0 ° to 20 °. There are two types of power supply options available: 24V DC and 220V AC.

Product Features

- Body Material: Aluminum alloy die-casting
- Optical System: Lens
- Finish: Static electricity powder coating
- Adjustable Angle: /
- Accessories: Embedded parts, suction cups, textured glass, honeycomb mesh
- Certification: CCC
- IP Rating: IP67/IK08 (load-bearing capacity 2000Kg)
- Insulation Level: Class III
- Operating Temperature: -20°C~50°C

Product Specifications

- LED Type: High Power
- Power: 7W(Max)
- Source Lm: 3000K 483lm;4000K 513lm
- LED Lifetime: >50000h-L70 /B10-Ta25°C(LM-80/TM-21)
- CCT/CRI: 3000K,Ra80 / 4000K,Ra80
- SDCM: 3 SDCM
- Input: 24V DC or 220V/AC
- Dimming: ON-OFF or DMX512 Dimming control
- Net Weight: 1.1Kg without packing

Order Model

Model	Comment	Power (W)	LEDs (quantity)	Max Lumens (lm)	Control Systems	Beam	CCT	Finish
EIS1S	T Frameless F Frame	07 7(Max)	3	356	ET ON-OFF 24V/DC Power Supply	S 8°	30 3000K 40 4000K	B Black (Frameless only) S Stainless Steel (Frame only)
					MT DMX512 Dimming 24V/DC Power Supply	1 15°		
					EL ON-OFF 220V/AC Power Supply	2 25°		
						4 45°		

Example:EIS1ST-07ET-S30-B

WAC Lighting
www.waclighting.com (US)
www.waclighting.com.cn (China)

Headquarters
44 Harbor Park Drive • Port Washington, NY
Phone (516) 515.5000 • Fax (516) 515.5050

WAC Lighting Technology (Shanghai) Co., Lt
14,Lane 299, Bi Sheng Road, Shanghai 201204
Phone (86.21) 3393.3558 • Fax (86.21) 3362.1598

FUEGO PRO- MODEL: EIS1S



In-ground Luminaires



PROJECT:

TYPE:

Accessory

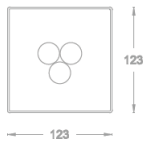
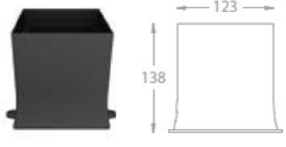
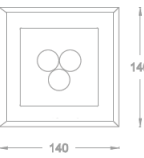
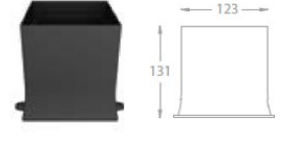
SQUARE	EMBEDEDE PART	SUCTION CUP	BEAM ELONGATOR	HONEYCOMB
Model	EIR1S Series	EIR1NT-SC001	EIS1ST-BEL001	EIS1ST-HCL001
EIS1ST	EIS1ST-RC001			
				
EIS1SF	EIS1SF-RC001			
				

LIGHT distribution@3000K LUMINAIRE DATA

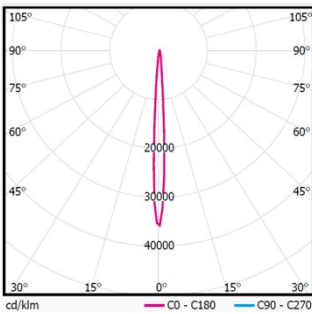

MODEL: EIS1ST-07EL-S30-B
ANGLE: 8°
POWER: 9.1W
LUMENS: 394lm
CBCP: /
EFFICACY: 43lm/W

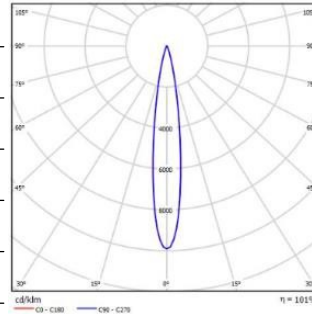

MODEL: EIS1ST-07EL-130-B
ANGLE: 15°
POWER: 9.2W
LUMENS: 360lm
CBCP: /
EFFICACY: 39lm/W

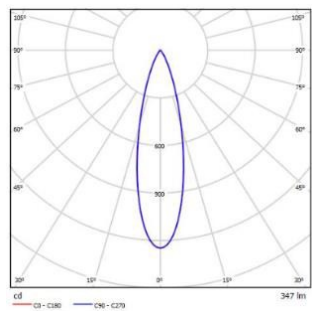

MODEL: EIS1ST-07EL-230-B
ANGLE: 25°
POWER: 8.7W
LUMENS: 347lm
CBCP: /
EFFICACY: 40lm/W

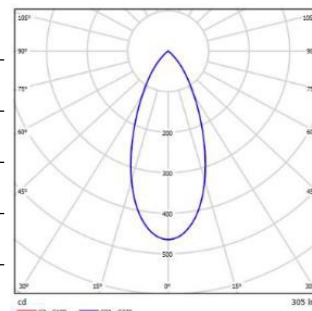

MODEL: EIS1ST-07EL-430-B
ANGLE: 45°
POWER: 8.7W
LUMENS: 305lm
CBCP: /
EFFICACY: 35lm/W